

ENERGIZER NO. EN92

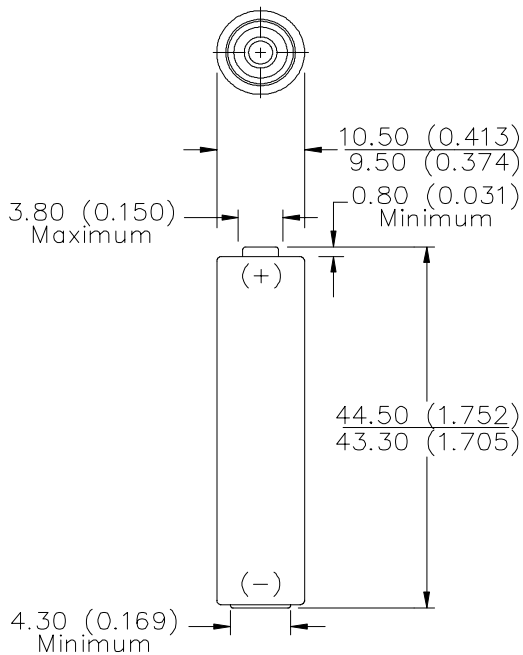

Industry Standard Dimensions in mm (inches)



AAA

NOT INTENDED FOR RETAIL TRADE

- Chemical System:** Alkaline
 Zinc-Manganese Dioxide (Zn/MnO₂)
 (No Added Mercury or Cadmium)
- Designation:** ANSI-24A, IEC-LR03
- Battery Voltage:** 1.5 Volts
- Internal Resistance:** 205 Milliohms (Fresh)
- Operating Temp:** -18°C to 55°C (0°F to 130°F)
- Average Capacity:** 1,250 mAh (to 0.8 volts)
 (Rated capacity at 25 mA continuous drain)
- Average Weight:** 11.5 grams (0.4 oz.)
- Volume:** 3.8 cubic centimeters (0.2 cubic inch)
- Cell:** One No. 3-312 (size 'AAA')
- Jacket:** Plastic Label
- Shelf Life:** 7 years (80% of rated capacity)

TEMPERATURE EFFECTS Typical Service to 0.8 Volts

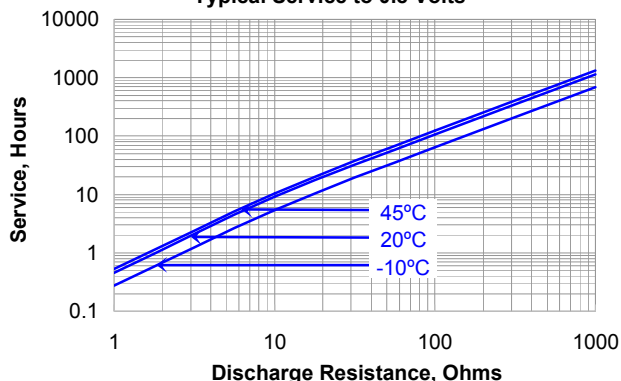

CONSTANT RESISTANCE PERFORMANCE Typical Service

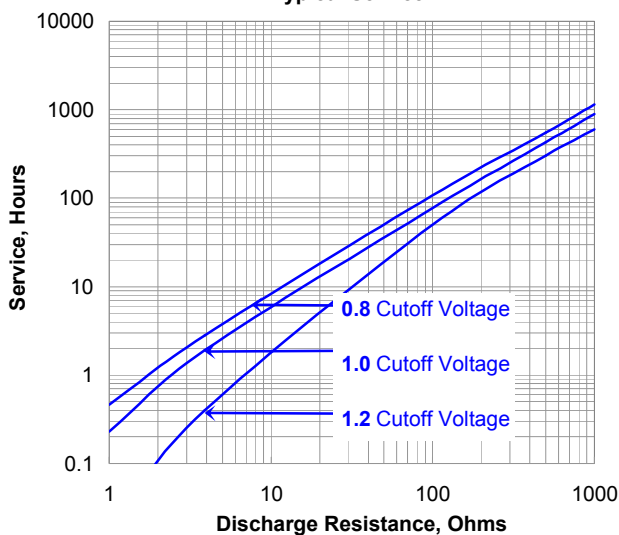

CONSTANT CURRENT DISCHARGE Typical Service

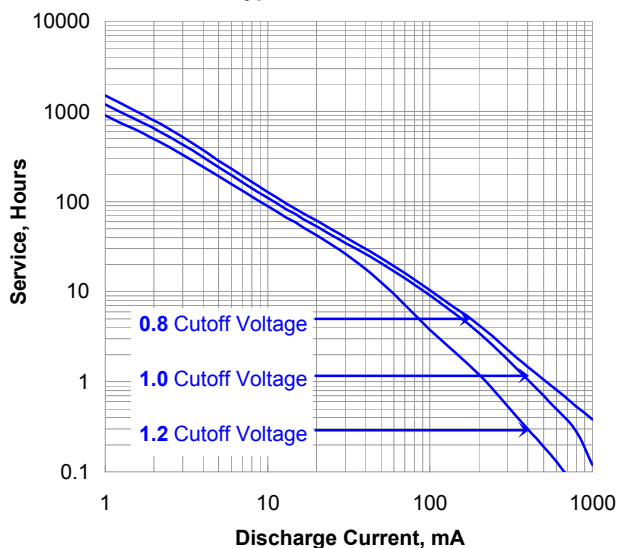

Important Notice

This data sheet contains information specific to batteries manufactured at the time of its publication.

Contents herein do not constitute a warranty.

Copyright © Eveready Battery Co. - All rights reserved

ENERGIZER NO. EN92

**CONSTANT POWER DISCHARGE
Typical Service**

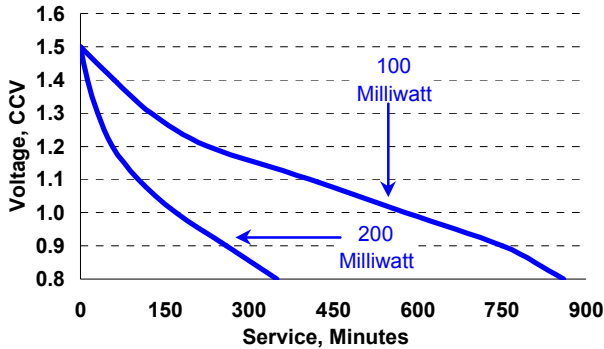

**CONSTANT POWER DISCHARGE
Typical Service**

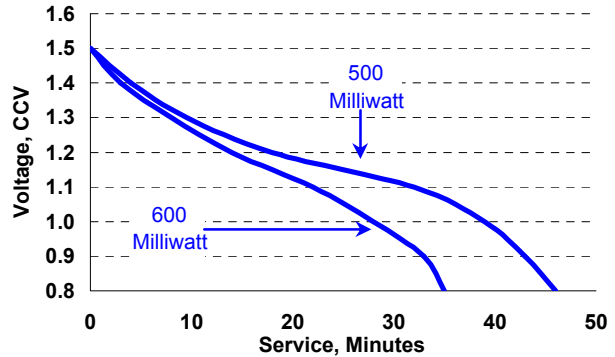

ANSI - IEC Industry Standard Tests @ 20° C

LIGHTING

5.1 ohm - 4 min/hr 8 hr/day

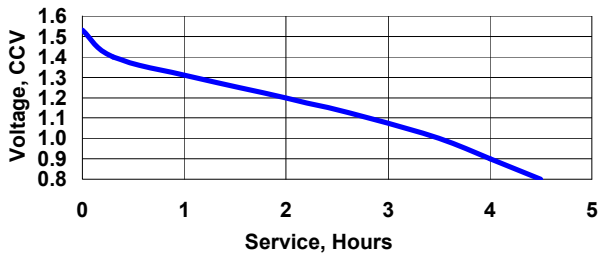

PAGER

1.2/120 mA - 10 sec/hr 24 hrs

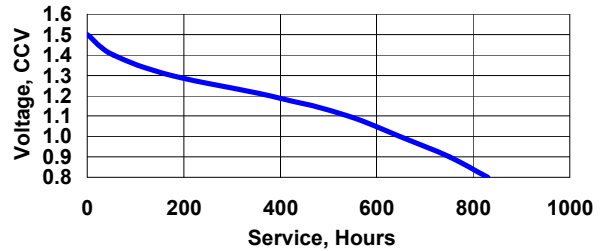

REMOTE

24 ohm - 15 spm - 8 hr/day



TAPE - ELECTRONIC GAMES

10 ohm - 1 hr/day

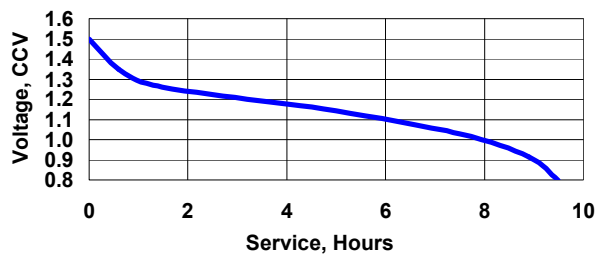

PHOTOFLASH

600 mA - 10 sec/min 1 hr/day

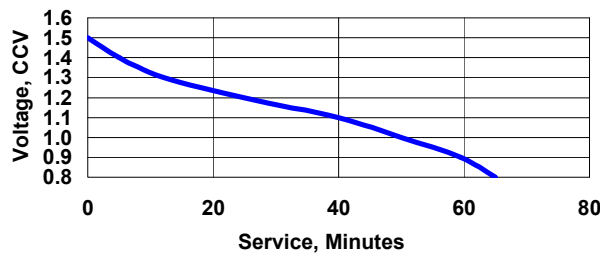

Important Notice

This data sheet contains information specific to batteries manufactured at the time of its publication.

Contents herein do not constitute a warranty.

Copyright © Eveready Battery Co. - All rights reserved