



PC1300

Size: D (LR20)

Alkaline-Manganese Dioxide Battery

Zn/MnO₂



Nominal Voltage:	1.5 V
Operating Voltage	1.6 - 0.75V
Impedance:	136 m-ohm @ 1kHz
Typical Weight:	139 gm (4.9 oz.)
Typical Volume:	56.4 cm ³ (3.4 in. ³)
Terminals:	Flat
Storage Temperature Range:	-20°C to 35°C
Operating Temperature Range:	-20°C to 54°C (-4°F to 130°F)
ANSI:	13A
IEC:	LR20

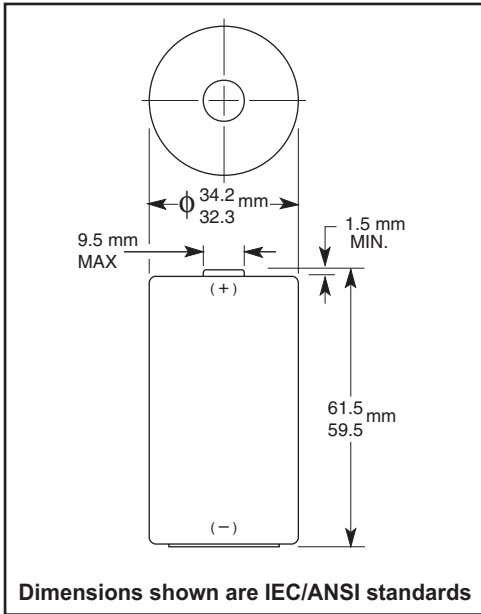

TYPICAL DISCHARGE CHARACTERISTICS AT 21°C (70°F)

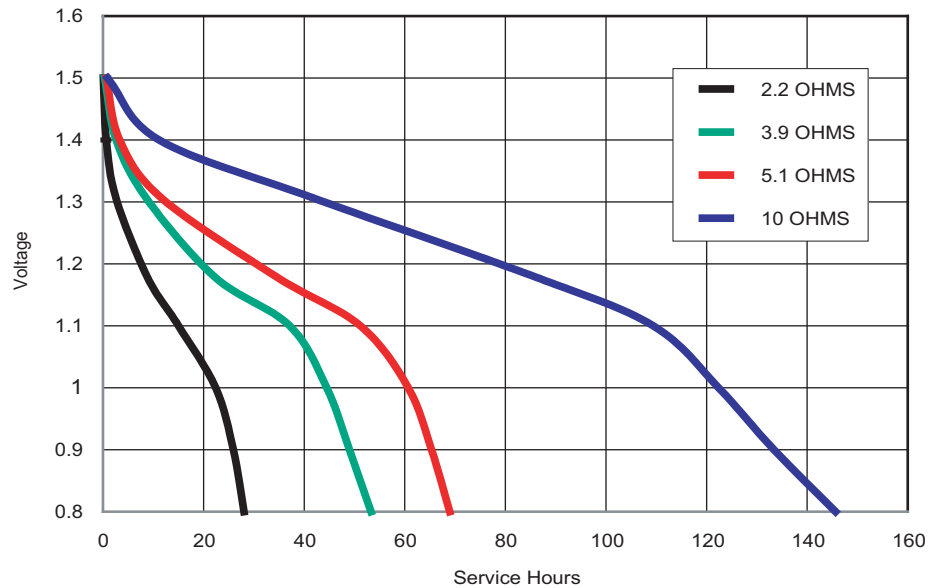

DURACELL
BATTERIES

Berkshire Corporate Park
Bethel, CT 06801 U.S.A.
Telephone: Toll-free 1-800-544-5454
Internet: www.duracell.com

* Delivered capacity is dependent on the applied load, operating temperature and cut-off voltage. Please refer to the charts and discharge data shown for examples of the energy / service life that the battery will provide for various load conditions.

Alkaline-Manganese Dioxide Battery

TYPICAL CONSTANT POWER DISCHARGE CHARACTERISTICS AT 21°C (70°F)

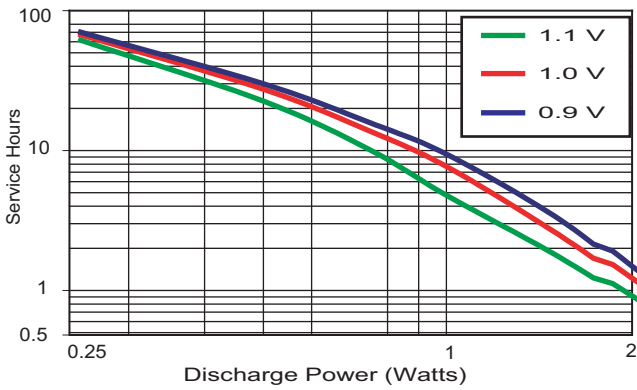

TYPICAL CONSTANT CURRENT DISCHARGE CHARACTERISTICS AT 21°C (70°F)

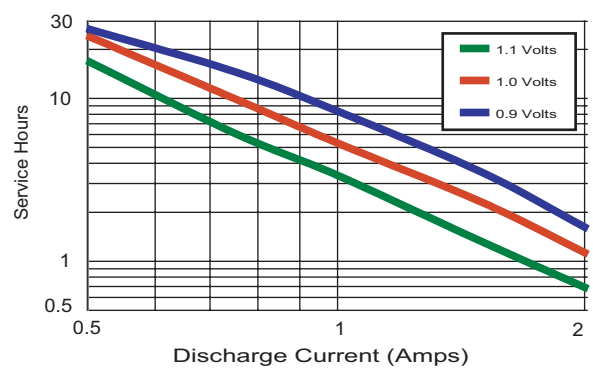

TYPICAL DISCHARGE CHARACTERISTICS AT 21°C (70°F)

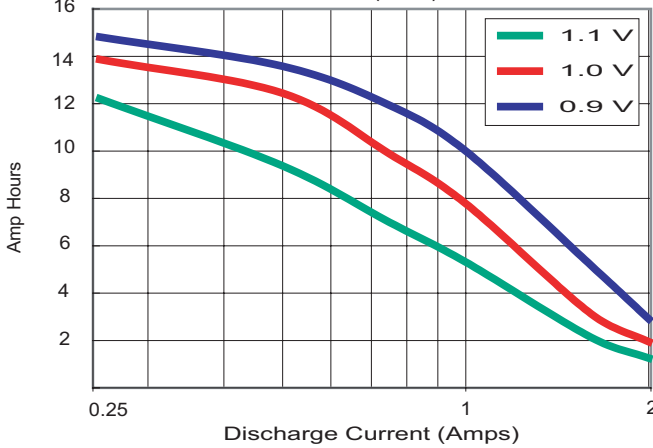

TYPICAL DISCHARGE CHARACTERISTICS AT 21°C (70°F)

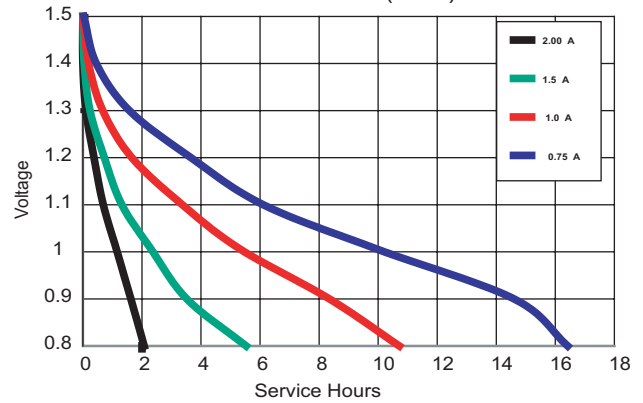

TYPICAL FLASHLIGHT TEST AT 21°C AND 0°C

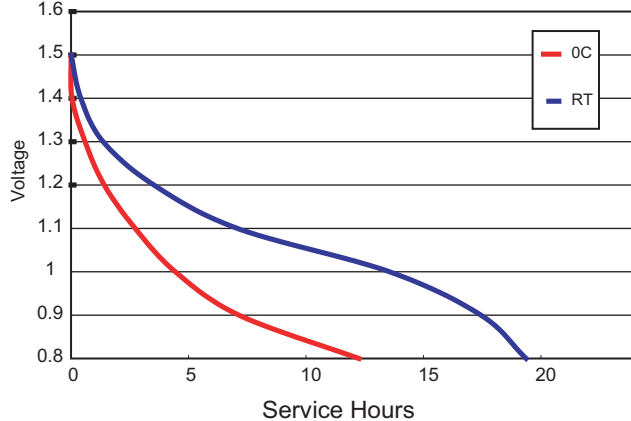

DURACELL®
 BATTERIES

Berkshire Corporate Park
 Bethel, CT 06801 U.S.A.
 Telephone: Toll-free 1-800-544-5454
 Internet: www.duracell.com

* Delivered capacity is dependent on the applied load, operating temperature and cut-off voltage. Please refer to the charts and discharge data shown for examples of the energy / service life that the battery will provide for various load conditions.